



九齊科技股份有限公司
Nyquest Technology Co., Ltd.

DATA SHEET

NY2P Series

6 I/O Dual-Tone or Speech Synthesizer

Version 1.0

Aug. 17, 2012

NYQUEST TECHNOLOGY CO. reserves the right to change this document without prior notice. Information provided by NYQUEST is believed to be accurate and reliable. However, NYQUEST makes no warranty for any errors which may appear in this document. Contact NYQUEST to obtain the latest version of device specifications before placing your orders. No responsibility is assumed by NYQUEST for any infringement of patent or other rights of third parties which may result from its use. In addition, NYQUEST products are not authorized for use as critical components in life support devices/systems or aviation devices/systems, where a malfunction or failure of the product may reasonably be expected to result in significant injury to the user, without the express written approval of NYQUEST.

Revision History

<i>Version</i>	<i>Date</i>	<i>Description</i>	<i>Modified Page</i>
1.0	2012/8/17	First release.	-

1. 概述

NY2P系列產品為單晶片CMOS音樂和語音合成 IC，是九齊科技為了支援 NY2AxxxA, NY2BxxxA, NY2CxxxA 系列MaskROM 產品所專門開發的嵌入式EPROM架構的OTP IC (One Time Programmable)，目前只有一個母體 NY2P010A。具有1個Input腳和 5個I/O腳，利用精準的內阻震盪(+/- 1%)，故不需外加震盪電阻，只有一組PWM 輸出，故無須再外加任何零件。音樂合成方式為可程式的方波和包絡線，語音和音樂合成方式與NY2A, NY2B, NY2C系列MaskROM產品相同，藉由OTP燒錄過程中更換Code資料，可自行將不同的語音資料寫入EPROM中。用戶可使用簡便的 Q-Tone, Q-Melody 和 Quick-IO 工具軟體來快速地進行開發。

2. 功能

(1). 寬廣的工作電壓：1.8V ~ 5.5V。

(2). 只有一個母體，音樂及語音共用一塊ROM，可支援的大約音樂音符或最大語音秒數(@6kHz)如下：

P/N	NY2P010A (Demo NY2A/2B)	NY2P010A (Demo NY2C)
Note	Max. 17,792	Avg. 7,872
Voice (sec)	Max. 11.86 sec	Max. 10.50 sec

※ 注意: 由於NY2C的Tone-1和Tone-2的音符所佔空間不同，所以可用的音符數量以平均值來計算。

NY2A, NY2B, NY2C MaskROM 產品的實際容量(Hex-16進制)和最大音樂音符或語音秒數(@6kHz)如下：

P/N	NY2A001A
Note	Max. 1,344
Voice (sec)	Max. 0.9 sec

P/N	NY2B001A	NY2B002A	NY2B004A	NY2B007A
Note	Max. 1,568	Max. 2,688	Max. 6,784	Max. 10,752
Voice (sec)	Max. 1.05 sec	Max. 1.79 sec	Max. 4.52 sec	Max. 7.17 sec

P/N	NY2C001A	NY2C003A	NY2C005A	NY2C008A	NY2C010A
Note	Avg. 1,104	Avg. 1,936	Avg. 4,096	Avg. 5,888	Avg. 7,744
Voice (sec)	Max. 1.47 sec	Max. 2.58 sec	Max. 5.46 sec	Max. 7.85 sec	Max. 10.33 sec

(3). 有6個I/O腳: OKY1只能作為輸入腳，OKY2/O5, IO1, IO2, IO3 和 IO4 可分別選擇作輸入腳或是輸出腳。(光罩選擇)

(4). 有6種矩陣按鍵(Matrix Key)輸入方式，加上VDD當其中一個輸出腳，In*Out 分別為: 4*3=12, 3*3=9, 4*2=8, 3*2=6, 2*3=6, 2*2=4，矩陣按鍵和單獨按鍵(Alone Key)可同時使用。

(5). 音樂和語音最多可被分割成最多128個語音音樂段(Voice/Melody Section)，每段長度可不同，每一語音音樂段中的語音音樂+靜音長度必須為 20H (Hex) 的整數倍。

(6). 最多有512個語音音樂格(Voice/Melody Step)，可規劃成128個語音音樂組(Voice/Melody Sentence)，OKY1、OKY2/O5、IO1、IO2、IO3、IO4 能分別指定 64、64、1、1、1、1 個語音音樂組(Sentence)。每一語音音樂格(Step)可指定任一個語音音樂段(Section)和 IO1、IO2、IO3、IO4、OKY2/O5 的輸出搭配 (當IOx設為輸出時)。

- (7). 語音和音樂不能同時輸出，只能選擇輸出一通道的語音或是兩通道的音樂，但是可以在語音音樂組中的語音音樂格分別填入語音段與音樂段，來實現在音樂的音符間隔中插入語音。
- (8). 音樂最多為兩通道(Tone-1 & Tone-2)，每個通道可分別自訂一組可程式的音色音源(Patch)和包絡線(Envelope)。每個音色音源(Patch)可選擇為8段或16段的可程式方波，8段方波可支援到第7個Octave的音域，16段方波只支援到第6個Octave的音域，每段方波可分別定義成 0%, 25%, 50% 或 100% 的高度，不同的高度設定可以讓音色產生更多變化。每個包絡線(Envelope)有128階變化，不同的包絡線畫法也會讓音色產生不同的變化。
- (9). 可支援音樂的拍子(Tempo)為25種： 234, 208, 188, 170, 156, 144, 134, 125, 117, 110, 104, 99, 94, 89, 85, 82, 78, 75, 72, 69, 67, 65, 63, 60, 59；可支援音樂的拍長(Beat)為8種: 4, 2, 1, 1/2, 1/4, 1/8, 1/16, 1/32。另外提供拍長合成功能，可以用8種固定拍長來組合出任意長度的拍長，例如: $1 + 2 = 3$, $1/2 + 1/4 = 3/4$, $1/4 + 1/8 + 1/16 = 7/16$, ...。合成後的拍長套用一個包絡線，且合成內的拍長可以指定相同或不同的音高和輸出。
- (10). 只有內建一組準確的頻率振盪器(+/- 1.0% 誤差)，並無提供外部震盪電阻選項。共有16種不同播放速度可供選擇，每一個語音音樂格(Voice/Melody Step)可選擇不同的播放速度來使用。

1	2	3	4	5	6	7	8
12.0kHz	10.8kHz	9.7kHz	8.9kHz	8.0kHz	7.5kHz	7.0kHz	6.5kHz
9	10	11	12	13	14	15	16
6.1kHz	5.8kHz	5.4kHz	5.2kHz	4.9kHz	4.7kHz	4.5kHz	4.3kHz

- (11). 輸入腳的輸入選項：(光罩選擇)
 - (a). 任一輸入腳可分別選擇 Edge/Level, Hold/Unhold, Retrigger/Irretrigger 不同的觸發方式組合。
 - (b). 任一輸入腳可分別選擇 CDS+1M、CDS、1M 的下拉電阻 或 Floating。(CDS+1M選項: 當按鍵按下時，IC內部為 1MΩ 的下拉電阻；而當按鍵放開時，IC內部為 300KΩ+1MΩ 並聯 的下拉電阻 約230KΩ。CDS選項: 當按鍵按下時，IC內部為 Floating；而當按鍵放開時，IC內部為 300KΩ 的下拉電阻。)
 - (c). 任一輸入腳可分別選擇Debounce時間：Long - 提供一般按鍵使用；Short - 提供彈跳開關使用。
 - (d). 任一OKY輸入腳(OKY1或OKY2/O5) 最多有64個Sentence的One-Key Sequential 或 Random 的選擇，在 One-Key Sequential 時並可選擇Sentence的播放順序在其他按鍵被觸發後是否要Reset。
 - (e). 有兩個輸入腳可選擇是否有 Toggle On/Off 的功能 (1st 觸發 → 播放, 2nd 觸發 → 停止,)。

※ 注意: 按鍵輸入的優先順序為 OKY1 > OKY2/O5 > IO1 > IO2 > IO3 > IO4。

- (12). 所有的輸出腳都可提供大電流輸出來直推高亮度LED。(I_{ol}=20mA @V_{DD}=3V)
- (13). 每個輸出腳都可分別設定為”定電流輸出”(Constant Sink Current, CSC)，以便在4.5V時限制電流輸出。
- (14). 所有的輸出腳都有以下 12 種輸出選項：(光罩選擇)
 - (a). Stop_Low pulse：停止播放時送出低位準脈衝。
 - (b). Stop_High pulse：停止播放時送出高位準脈衝。
 - (c). Busy_High active：播放時送出高位準訊號。(Drive輸出)
 - (d). Busy_Low active：播放時送出低位準訊號。(Sink輸出)
 - (e). LED 2Hz flash：播放時 LED 2Hz Drive或Sink輸出閃爍。

- (f). LED 4Hz flash : 播放時 LED 4Hz Drive或Sink輸出閃爍。
- (g). LED 8Hz flash : 播放時 LED 8Hz Drive或Sink輸出閃爍。
- (h). LED 16Hz flash : 播放時 LED 16Hz Drive或Sink輸出閃爍。
- (i). LED dynamic 1/2 : 播放時 LED根據1/2聲音位準做Drive或Sink輸出動態閃爍。
- (j). LED dynamic 3/4 : 播放時 LED根據3/4聲音位準做Drive或Sink輸出動態閃爍。
- (k). QIO訊號: 可隨語音作任意的輸出變化, 每一個語音格(Step)可選擇一組QIO訊號, 用戶使用此功能需先開啓Quick-IO編輯器來做QIO訊號編輯。(只支援IO1和IO2)
- (l). QLED訊號: 可隨音樂作輸出的變化, 每一個音符都可選擇一種QLED訊號, 用戶使用此功能需搭配九齊的Q-Melody軟體來做QLED訊號編輯。QLED訊號有11種狀態可供選擇: 根據包絡線時間長度來漸明、根據包絡線時間長度來漸暗、根據包絡線閃一下、根據音符閃一下、根據音符8Hz閃爍、根據音符16Hz閃爍、亮度為0%(全暗)、亮度為25%(1/4亮度)、亮度為50%(2/4亮度)、亮度為75%(3/4亮度)、亮度為100%(全亮)。(所有IOx 都只隨Tone-1音符做變化)

※ 注意: LED 2Hz / 4Hz / 8Hz / 16Hz flash 是指以 8kHz 的播放速度 時LED閃爍的頻率; 不同的播放速度, LED閃爍的頻率也會不同。但當播放音樂時, LED閃爍固定為 2Hz / 4Hz / 8Hz / 16Hz flash。

- (15). 特殊功能選項 "模式切換" (Mode-Switch): 有兩種功能模式, 可使用IO2或IO4輸入來當作模式切換開關 (Mode-Switch), 模式一(IO2→GND) 與 模式二(IO2→VDD) 的所有輸出型態(Output Type)只能相同, 但是I/O功能和語音音樂內容可以不同。
 - (16). 特殊功能選項 "上電播放" (Power-On-Play, POP): 電池一上電立即播放一次"上電播放語音音樂組"(POP Sentence), 觸發模式固定為 Edge / Unhold / Retrigger。如果POP結合Power-On-Loop功能, 則上電會循環播放"上電播放語音音樂組"(POP Sentence), 直到其他按鍵被觸發才會停止, 當其他按鍵被觸發時, "上電播放語音音樂組"(POP Sentence)會立即停止播放並播放該按鍵所指定的語音音樂組。如果POP結合Mode-Switch功能, 則當模式切換後會先播放一次"上電播放語音音樂組"(POP Sentence)。
 - (17). 特殊功能選項 "短觸發循環播放" (Edge-Loop): 此功能有兩組。當OKY1 (OKY2) 按鍵一被觸發, 該觸發按鍵所指定的語音音樂組會一直循環播放。如果結合 One-Key Sequential 功能, 再次觸發該按鍵, 會循環播放下一個語音音樂組。如果結合 Loop On/Off 功能, 再觸發該按鍵, 聲音會停止, 再次觸發則循環播放下一個語音音樂組。如果結合 Loop-End 功能, 在播放OKYx最後一個語音音樂組時再次觸發該按鍵, 聲音會停止, 再次觸發則回到第一個語音音樂組進行循環播放。
- ※ 注意: Loop On/Off 與 Toggle On/Off 不能同時存在。
- (18). 特殊功能選項 "長觸發順序循環播放" (Level-Sequential): 此功能有兩組。當OKY1 (OKY2) 按鍵被觸發後持續按著, 會依序播放OKY1 (OKY2) 所指定的語音音樂組, 一直循環播放 (S1, S2, S3, S1, S2, S3,), 按鍵離開則聲音立即停止(Hold mode)或播完該語音音樂組後停止(Unhold mode), 再按著按鍵則播放下一個語音音樂組, 然後仍然依序循環播放。如果結合Edge-Loop功能, OKYx按鍵被觸發後(不需持續按著), 會依序播放OKYx所指定的語音音樂組, 一直循環播放, 再次觸發該按鍵, 會立即播放下一個語音音樂組, 然後仍然依序循環。如果結合Edge-Loop 和 Loop On/Off 功能, 再次觸發該按鍵, 聲音會停止, 再觸發則播放下一個語音音樂組, 然後仍然依序循環播放。

- (19). 特殊功能選項 "選曲功能" (Voice-Select)：此功能有兩組。此時OKY1 (OKY2) 為選曲鍵，IO2 (IO1) 為播放鍵；先用OKYx來依序選擇語音音樂組，當IOx按鍵一被觸發，則會播放OKYx所選擇的語音音樂組。(此功能常見於門鈴的應用)
- (20). 特殊功能選項 "鬧鐘/貪睡功能" (Alarm/Snooze)：此時IO1或IO2可設為鬧鐘開關，OKY1或其他IO可設為貪睡按鍵。當鬧鐘開關在開啓狀態時，如果鬧鐘時間到達，會先播放鬧鐘所指定的語音音樂組一次，然後接著循環播放特定的"循環語音音樂組"(Loop Sentence)，直到鬧鐘時間結束；在鬧鐘聲音播放時，如果關閉鬧鐘開關，則停止播放鬧鐘聲音，並播放一次特定的"跳躍語音音樂組"(Jump Sentence)；在鬧鐘聲音播放時，如果按一下貪睡鍵，則停止播放，並依照貪睡按鍵所設定的貪睡時間來等待，直到貪睡時間結束，接著會循環播放特定的"循環語音音樂組"(Loop Sentence)。如果結合OKY2的Voice-Select功能，IO1設為鬧鐘開關，則到達鬧鐘時間，會播放OKY2所選擇的語音音樂組一次，然後接著循環播放特定的循環語音音樂組(Loop Sentence)，也可以將 Loop Sentence 設定為 IO1 Sentence，則到達鬧鐘時間，會一直循環播放OKY2所選擇的語音音樂組，當關閉鬧鐘開關，則播放一次跳躍語音音樂組(Jump Sentence)。
- ※ 注意: Loop Sentence 和 POP Sentence 共用同一個語音音樂組。*
- (21). 特殊功能選項 "內部觸發" (Internal-Feedback)：此功能有兩組。當OKY1(OKY2), IO1(IO3) 或 IO2(IO4) 的聲音停止播放或播放結束時，利用內部的Stop_High-Pulse信號來自動觸發OKY1, IO1或IO2所指定的語音音樂組(Internal-Feedback Path)，播放該語音音樂組一次。
- ※ 注意: 當啟動此功能時，IO2 或 IO4 只能當做輸入腳。*
- (22). 特殊功能選項 "雜訊觸發" (Noise-Trigger)：當選擇此功能時，OKY1被設定為 Edge/Unhold 功能，應用時需將OKY1輸入在PCB的Layout做成較長的輸入線，當外部有較大的雜訊產生時，利用天線效應的原理來產生輸入訊號，OKY1外部懸空不需連接到VDD或GND腳。(此功能常見於電子打火機和手機天線的應用)
- (23). 特殊功能選項 "馬達復位" (Motor-Recover)：此功能有兩組。當使用復位馬達時可選擇此功能，此時只能將IO1(IO2)輸出腳連接到復位馬達來做馬達控制，並將馬達復位點連接到OKY2/O5 或 IO3 (IO4) 的輸入腳來做復位偵測。(光罩選擇)
- (24). 序列觸發功能(Serial-Trigger): 在 Edge/Unhold/Retrigger 觸發模式下，使用OKY1或OKY2的 One-Key Sequential 和 Reset 功能，並設定觸發Debounce時間為Short Debounce，這樣就可以利用外部序列訊號輸入來控制OKYx 的特定Sentence播放，通常搭配外部MCU來控制。**
- (25). 一組PWM輸出，有兩種PWM音量可供選擇(正常音量&大音量)，可直接驅動8Ω、16Ω、32Ω、64Ω的喇叭或蜂鳴片。
- (26). 低壓復位(LVR) 選項，當電壓瞬間低於1.8V時，IC 會自動復位。(光罩選擇)
- (27). 提供特殊的快速燒錄模式，以加快OTP燒錄時間。
- (28). 支援特殊的ICP (In Circuit Programming) 燒錄功能，以方便客戶先組裝PCBA模組再進行燒錄。
- (29). 提供可程式的Code資料保護模式。*(當Security-Bit 被燒斷後，資料將無法讀取。)*
- (30). 提供多種出貨型態，以滿足客戶不同的應用需求。

(要進一步了解上述功能，請參考Q-Tone的使用手冊，或聯繫九齊科技或九齊代理商。)

1. GENERAL DESCRIPTION

The NY2P series is single-chip dual-tone melody or 1-ch voice synthesizing CMOS IC. It's OTP (One Time Programmable) IC with embedded EPROM architecture, that is designed to support NY2AxxxA, NY2BxxxA and NY2CxxxA MaskROM products. There is only one body: NY2P010A. It has one input and five I/O pins. Through the accurate internal oscillation of +/- 1% tolerance and one built-in PWM output, thus any external component is not required. Using the same melody and speech algorithm as NY2A, NY2B and NY2C, customer's melody and speech data can be written into EPROM by different code data. Besides, the interactive software developing tools of "Q-Tone", "Q-Melody" & "Quick-IO" are user-friendly and quick for programming, then users can write BIN code into OTP very fast by "Q-Writer" software cooperating with "OTP_Writer" hardware.

2. FEATURES

- (1). Wide operating voltage: 1.8V ~ 5.5V.
- (2). There is only one body. The ROM data is shared by dual-tone melody and voice together. The maximum or average number of dual-tone notes or the maximum duration of voice duration @6kHz are as following.

P/N	NY2P010A (Demo NY2A/2B)	NY2P010A (Demo NY2C)
Note	Max. 17,792	Avg. 7,872
Voice (sec)	Max. 11.86 sec	Max. 10.50 sec

※ Note: The number of notes is estimated by average of Tone-1 and Tone-2 because the ROM usage of Tone-1 is different from Tone-2 for NY2C.

For NY2A, NY2B and NY2C MaskROM product series, the actual ROM size in Hex and maximum/average number of dual-tone notes or the maximum duration of voice duration @6kHz are as following.

P/N	NY2A001A
Note	Max. 1,344
Voice (sec)	Max. 0.9 sec

P/N	NY2B001A	NY2B002A	NY2B004A	NY2B007A
Note	Max. 1,568	Max. 2,688	Max. 6,784	Max. 10,752
Voice (sec)	Max. 1.05 sec	Max. 1.79 sec	Max. 4.52 sec	Max. 7.17 sec

P/N	NY2C001A	NY2C003A	NY2C005A	NY2C008A	NY2C010A
Note	Avg. 1,104	Avg. 1,936	Avg. 4,096	Avg. 5,888	Avg. 7,744
Voice (sec)	Max. 1.47 sec	Max. 2.58 sec	Max. 5.46 sec	Max. 7.85 sec	Max. 10.33 sec

- (3). Six I/O pins: OKY1 can only be input pin. Other OKY2/O5, IO1, IO2, IO3 and IO4 can be either input or output pin (Mask option).
- (4). There are six kinds of Matrix Key input. With an extra output pin of VDD, the combination of In*Out are as: 4*3=12, 3*3=9, 4*2=8, 3*2=6, 2*3=6, 2*2=4. Matrix Key can cooperate with Alone Key.
- (5). The total melody and voice duration can be partitioned up to maximum 128 *Voice/Melody Sections*. Each *Voice/Melody Section* length is flexible. The *Voice/Melody Section* length of "voice/melody length + mute length" must be the multiple of 20H (Hex).

- (6). Total maximum 512 *Voice/Melody Steps* are available for 128 *Voice/Melody Sentences*. OKY1, OKY2/O5, IO1, IO2, IO3, IO4 input can assign 64, 64, 1, 1, 1, 1 *Sentences* independently. Each *Step* can specify one *Voice/Melody Section* and enable/disable IO1, IO2, IO3, IO4 and OKY2/O5 output option if IOx is set as output.
- (7). Dual-Tone melody and voice can't be played simultaneously. Meanwhile either melody or voice can be played only. User can fill out different Voice Section and Melody Section into Steps of one Sentence to achieve voice playing among melody notes.
- (8). There are maximum two channels of Tone-1 and Tone-2 for melody. Each channel can assign one set of programmable patch and envelope. Each patch can be one of 8-step or 16-step programmable square waveform. The 8-step patch can support the pitch range up to the 7th octave, and other 16-step patch can support up to the 6th octave. There are 4-level altitudes of 0%, 25%, 50% and 100% for each square step. Through level change of different altitude, the timbre will be much of variety. In addition, there are 128-level altitudes for each envelope, and it can make timbre more various.
- (9). There are 25 kinds of tempo: 234, 208, 188, 170, 156, 144, 134, 125, 117, 110, 104, 99, 94, 89, 85, 82, 78, 75, 72, 69, 67, 65, 63, 60, 59. And there are 8 kinds of beat: 4, 2, 1, 1/2, 1/4, 1/8, 1/16, 1/32. Besides, a beat synthesizing function is provided to synthesize arbitrary beat. For examples, 1 + 2 = 3, 1/2 + 1/4 = 3/4, 1/4 + 1/8 + 1/16 = 7/16, The synthesized beat imitates the original envelope, and the synthesizing beats can assign the same or different pitch and output option.
- (10). Only build in an accurate internal oscillator of +/- 1.0% tolerance, no external R oscillator. There are 16 kinds of options for play speed, and each *Step* can select any one of them independently.

1	2	3	4	5	6	7	8
12.0kHz	10.8kHz	9.7kHz	8.9kHz	8.0kHz	7.5kHz	7.0kHz	6.5kHz
9	10	11	12	13	14	15	16
6.1kHz	5.8kHz	5.4kHz	5.2kHz	4.9kHz	4.7kHz	4.5kHz	4.3kHz

- (11). Input option for input pin. (Mask option)
 - (a). Each input can select Edge/Level, Hold/Unhold and Retrigger/Irtrigger trigger modes.
 - (b). Each input can select CDS+1M, CDS, 1M pull-low resistor or Floating type.
 - (CDS+1M option: Only 1MΩ pull-low resistance at key-pressed, and 300KΩ+1MΩ in parallel pull-low resistance around 230KΩ at key-released. CDS option: Floating at key-pressed, and 300KΩ pull-low resistance at key-released.)
 - (c). Each input can select Debounce time: Long debounce for push-button. Short debounce for fast switch.
 - (d). Each OKY input (OKY1 or OKY2/O5) can select One-Key Sequential or Random for maximum 64 *Sentences* independently. At One-Key Sequential, the Reset function of playing *Sentence* sequence can be enabled or disabled when other keys are triggered.
 - (e). Two input pins can select Toggle On/Off function (1st Trigger → play, 2nd trigger → stop,).

※ Note: Input priority is OKY1 > OKY2/O5 > IO1 > IO2 > IO3 > IO4.

- (12). All output pins support large-current output and can directly drive high brightness LED. (I_o=20mA@V_{DD}=3V)

- (13). All output pins can be set as Constant Sink Current (CSC) output individually for current limit at 4.5V.
- (14). There are 12 kinds of output option for all output pins. (Mask option)
- (a). Stop_Low pulse: Low active stop-pulse output whenever device stop playing.
 - (b). Stop_High pulse: high active stop-pulse output whenever device stop playing.
 - (c). Busy_High active: high active signal output during playing. (Drive output)
 - (d). Busy_Low active: low active signal output during playing. (Sink output)
 - (e). LED 2Hz flash: 2Hz Sink or Drive signal output to drive LED during playing.
 - (f). LED 4Hz flash: 4Hz Sink or Drive signal output to drive LED during playing.
 - (g). LED 8Hz flash: 8Hz Sink or Drive signal output to drive LED during playing.
 - (h). LED 16Hz flash: 16Hz Sink or Drive signal output to drive LED during playing.
 - (i). LED dynamic 1/2: according to 1/2 sound level, dynamic Sink or Drive signal output to drive LED.
 - (j). LED dynamic 3/4: according to 3/4 sound level, dynamic Sink or Drive signal output to drive LED.
 - (k). QIO signal: arbitrary output with voice. Each *Voice Step* can select one set of QIO signal and user can edit the QIO signal by “Quick-IO” editor. (*QIO signal only provided for IO1 & IO2.*)
 - (l). QLED signal: output with melody. Each note can select one kind of QLED signal and user can edit the QLED signal by “Q-Melody” or by Midi editor such like *Cakewalk*. There are 11 kinds of QLED signal: Ascend by envelope length, Descend by envelope length, Flash once by envelope, Flash once by note, Flash 8Hz, Flash 16Hz, 0% brightness (Off), 25% brightness (1/4), 50% brightness (2/4), 75% brightness (3/4), 100% brightness (On). (*All IOx vary with Tone-1 note.*)

※ Note: Where (e) ~ (h) is the LED flash rate at 8kHz sample rate. For different play speed, the LED flash rate is different from original 2Hz, 4Hz, 8Hz or 16Hz. While playing melody, the LED flash rate is fixed as 2Hz, 4Hz, 8Hz or 16Hz up to the output option.

- (15). “Mode-Switch” special function: There are two kinds of functional modes that can be switched by IO2 or IO4 input (Mode-Switch). For Mode-1 (IO2 → GND) and Mode-2 (IO2 → VDD), the output type of I/O setting is the same, but I/O function and voice/melody can be different.
- (16). “Power-On-Play” special function (POP): When power is on, play the POP Sentence one time. The trigger mode is fixed as Edge / Unhold / Retrigger. To cooperate with Power-On-Loop function, the POP Sentence will be played in loop until other key-trigger happened. When other key is triggered, it stops playing the POP Sentence and immediately plays the assigned sentence of triggered key. To cooperate with Mode-Switch function, the POP Sentence will be played first when mode is switched.
- (17). “Edge-Loop” special function: There are 2 sets of this function. When OKY1(OKY2) is triggered, playing the assigned sentence in loop. To cooperate with One-Key Sequential function, playing the next assigned sentence in loop once key is triggered again. To cooperate with Loop On/Off function, stop playing if trigger once more, and play the next assigned sentence in loop once key is triggered again. To cooperate with Loop-End function, stop playing if trigger once more when playing the last sentence of OKYx, and play the first sentence in loop once key is triggered again.

※ Note: Loop On/Off and Toggle On/Off cannot be optioned together.

- (18). “*Level-Sequential*” special function: There are 2 sets of this function. When OKY1(OKY2) is triggered and held, playing the assigned sentences sequentially in loop (S1, S2, S3, S1, S2, S3, ...), and stop playing at Hold mode or playback the sentence at Unhold mode after key is released. Holding key again to play the next sentences sequentially in loop as usual. To cooperate with Edge-Loop function, playing the assigned sentences sequentially in loop when OKYx is triggered and not held. Trigger once more to play the next sentences sequentially in loop as usual. To cooperate with both Edge-Loop and Loop On/Off function, stop playing if trigger once more, and play the next sentences sequentially in loop once key is triggered again.
- (19). “*Voice-Select*” special function: There are 2 sets of this function. OKY1(OKY2) is set as a select key to pick the desired sentence, and IO2(IO1) is set as a play key to play this selected sentence. When a desired sentence is selected through OKYx sequential playing, to trigger IOx will play this sentence. It’s popular in doorbell application.
- (20). “*Alarm/Snooze*” special function: Either IO1 or IO2 can be set as an alarm clock switch to play alarm, and OKY1 or other IO can be set as a snooze button. When IO1(IO2) alarm switch is turned on and alarm time is up, play the IO1(IO2) sentence one time and then play the “*Loop Sentence*” in loop until alarm period is over. Once turn off IO1(IO2) switch while alarm playing, stop alarm playing and then play the “*Jump sentence*” one time. Once press the snooze button while alarm playing, stop alarm playing and then wait for one period of snooze time. After snooze is over, the “*Loop Sentence*” will be played in loop. To cooperate with Voice-Select function of OKY2, IO1 is set as the alarm clock switch and the OKY2 selected sentence is assigned to be IO1 sentence. When alarm time is up, play the OKY2 assigned sentence one time and then play the Loop Sentence in loop. If IO1 sentence is assigned to be Loop Sentence in the meanwhile, when alarm time is up, play the OKY2 assigned sentence in loop. Once turn off alarm switch while alarm playing, stop alarm playing and then play the Jump sentence one time.
- ※ Note: Loop Sentence and POP Sentence share the same sentence.*
- (21). “*Internal-Feedback*” special function: There are 2 sets of this function. When the playing sentence of OKY1(OKY2), IO1(IO3) or IO2(IO4) is stopped or over, continue to play the assigned sentence of OKY1(OKY2), IO1(IO3) or IO2(IO4) through internal Stop_High-Pulse signal (Internal-Feedback Path).
- ※ Note: When enable this function, IO2 or IO4 is fixed as input pin.*
- (22). “*Noise-Trigger*” special function: When this function is selected, OKY1 is set as Edge/Unhold function. In PCB layout, OKY1 input needs a longer input line. By antenna effect, it takes place an input signal when larger noise happens outside. OKY1 is floating externally and is not necessary to connect to VDD or GND. It’s popular in electric lighter or mobile antenna application.
- (23). “*Motor-Recover*” special function: There are 2 sets of this function. User can select this function when using the recovering motor. In this application, IO1 (IO2) is set as output to control the recovering motor. And the motor recovering sensor must be connected to OKY2/O5 or IO3 (IO4) to detect the recovering signal. (Mask option)

- (24). Serial-Trigger function: In Edge/Unhold/Retrigger mode, by using the One-Key Sequential and Reset functions of OKY1 or OKY2 and setting the Debounce time to be short, IC can access external serial clock signal to playback the specific Sentence of OKYx. Usually it cooperates with an external MCU.
- (25). There are 2 kinds of PWM output, normal and large. It can directly drive 8, 16, 32, 64Ω speaker or piezo-buzzer.
- (26). Low-Voltage-Reset (LVR) option. When voltage is lower than 1.8V, IC will reset by itself. (Mask Option)
- (27). A unique fast writing mode is provided to speed up OTP writing time.
- (28). A special *ICP* (In Circuit Programming) writing function is supported for user to fabricate PCBA in advance.
- (29). Programmable code protection is provided. *(When the Security-Bit is burnt down, data can't be read.)*
- (30). Various shipping type for different application requirement.

(For details of the above functions, please refer to Q-Tone user manual, or contact Nyquest or her agents.)

3. BLOCK DIAGRAM

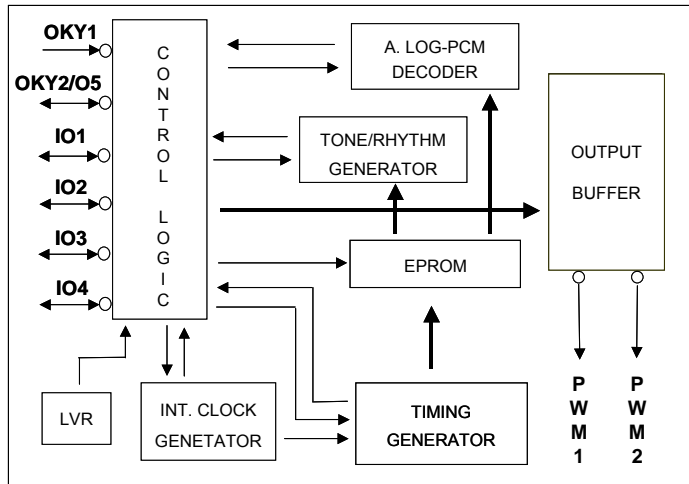

4. PAD DESCRIPTION

Pad Name	Pad No.	ATTR.	Description
OKY1/VPP	1	I	Input pin, active high, or positive high power for programming.
OKY2/O5	2	I/O	Output or input pin. To be input, active high.
IO1/SDA	3	I/O	Output or input pin. To be input, active high.
IO2/SCL	4	I/O	Output or input pin. To be input, active high.
IO3	5	I/O	Output or input pin. To be input, active high.
IO4	6	I/O	Output or input pin. To be input, active high.
V _{REG}	7	Power	Regulator input. Connect a 0.1uF cap to GND or keep floating.
GND	8	Power	Negative power.
VDD	9	Power	Positive power.
PWM1	10	O	PWM output 1.
PWM2/Mode	11	O	PWM output 2, or select programming mode.

5. DEVELOPMENT, DEMONSTRATION

User can use “Q-Tone” & “Quick-IO” software tools to develop the desired functions. After finishing the code programming, user will get 2 files of “.bin” and “.htm”, the binary file and function check list. Through “FDB_Writer” operation, user can download the “.bin” file into NY2_FDB flash demo board to demonstrate the NY2P function. Once the function has been approved, user only need to send the “.bin” file to Nyquest for code release. For more details, please refer to “Q-Tone” & “Quick-IO” user manual.

2Mb Flash Demo board	NY2_FDB-02
Max. demo body	NY2P010A

6. ABSOLUTE MAXIMUM RATING

Symbol	Rating	Unit
VDD~GND	-0.5 ~ +7.0	V
V _{in}	GND-0.3 < V _{in} < VDD+0.3	V
V _{out}	GND < V _{out} < VDD	V
T _{op} (operating)	-0 ~ +70	°C
T _{st} (storage)	-55 ~ +150	°C

7. DC CHARACTERISTICS

Symbol	Parameter	Min.	Typ.	Max.	Unit	Condition
V _{DD}	Operating voltage	1.8	3.0	5.5	V	
I _{sb}	Standby current, V _{DD} =3V/4.5V		0.1	0.5	uA	No loading
I _{op}	Operating current		1200			
			1500			
I _{ih}	Input current (1M ohms pull-low)		3		uA	V _{DD} =3V
			10			V _{DD} =4.5V
I _{oh}	Output drive current		-7		mA	V _{DD} =3V, V _{oh} =2.0V
			-11			V _{DD} =4.5V, V _{oh} =3.5V
I _{ol}	Output sink current		20		mA	V _{DD} =3V, V _{ol} =1.0V
			30			V _{DD} =4.5V, V _{ol} =1.0V
	Output constant sink current		20		mA	V _{DD} =3V, V _{ol} =1.0V
			20.5			V _{DD} =4.5V, V _{ol} =1.0V
I _{oh}	PWM1, PWM2 output current (Normal)		-65		mA	V _{DD} =3V, V _{oh} =1.5V
I _{ol}			65			V _{DD} =3V, V _{ol} =1.5V
I _{oh}	PWM1, PWM2 output current (Large)		-75		mA	V _{DD} =3V, V _{oh} =1.5V
I _{ol}			75			V _{DD} =3V, V _{ol} =1.5V
ΔF/F	Frequency deviation by voltage drop	V _{DD} =3V	0.5		%	$\frac{F_{osc}(3.0v)-F_{osc}(2.4v)}{F_{osc}(3v)}$
		V _{DD} =4.5V	0.3			$\frac{F_{osc}(4.5v)-F_{osc}(3.0v)}{F_{osc}(4.5v)}$
ΔF/F	Frequency lot deviation, (V _{DD} =3V)	-1.0		1.0	%	$\frac{F_{max}(3.0v)-F_{min}(3.0v)}{F_{max}(3.0v)}$
F _{osc}	Oscillation Frequency	1.23	1.54	1.65	MHz	V _{DD} =1.8~5.5V

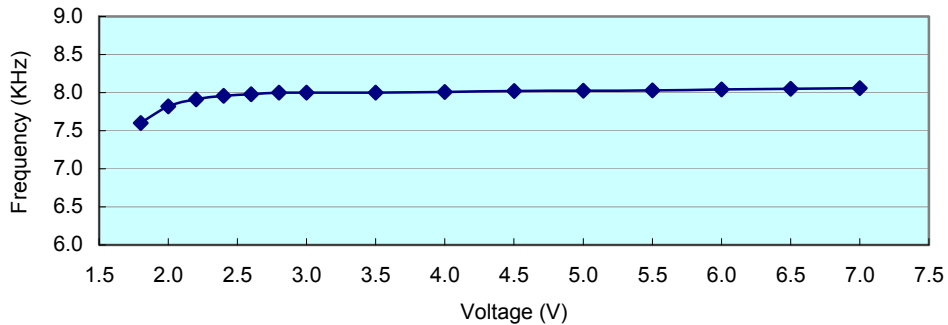
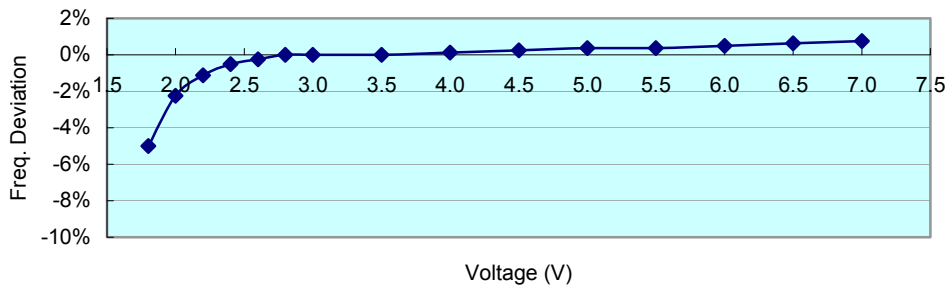
Voltage vs Frequency (SR=6.0KHz@3V)

Voltage vs Freq. Deviation (SR=6.0KHz@3V)

8. TIMING DIAGRAM

(1) Debounce Time

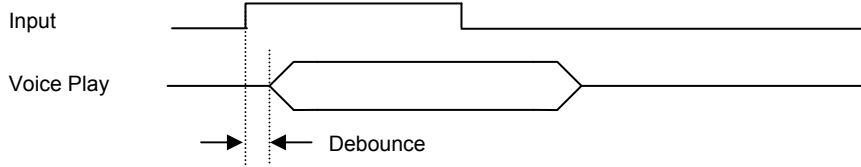
(a). Trigger while no playing voice



※ Debounce time is configured by 6 kHz S.R and the value is fixed. That is, Long debounce = 20ms, Short debounce = 50us

(b). Trigger While playing voice

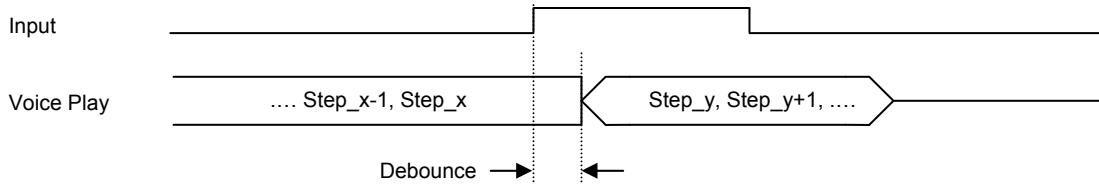

※ Debounce Time is configured by the S.R. of Step_x. At S.R. = 6kHz, Long debounce = 20ms, Short debounce = 50us

For example, if Step_x S.R. = 8kHz, Long debounce = 20ms*(6k/8k) = 15ms, Short debounce = 50us*(6k/8k) = 37.5us

(2) Input Priority

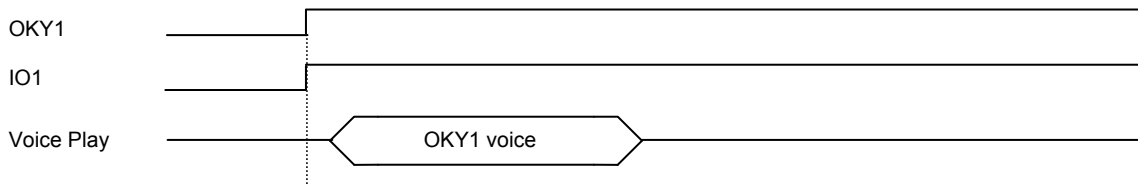

※ Priority: OKY1 > OKY2/O5 > IO1 > IO2 > IO3 > IO4 > POP(Power-On-Play)

(3) Output Signal (IO1, IO2, IO3, IO4, O5)

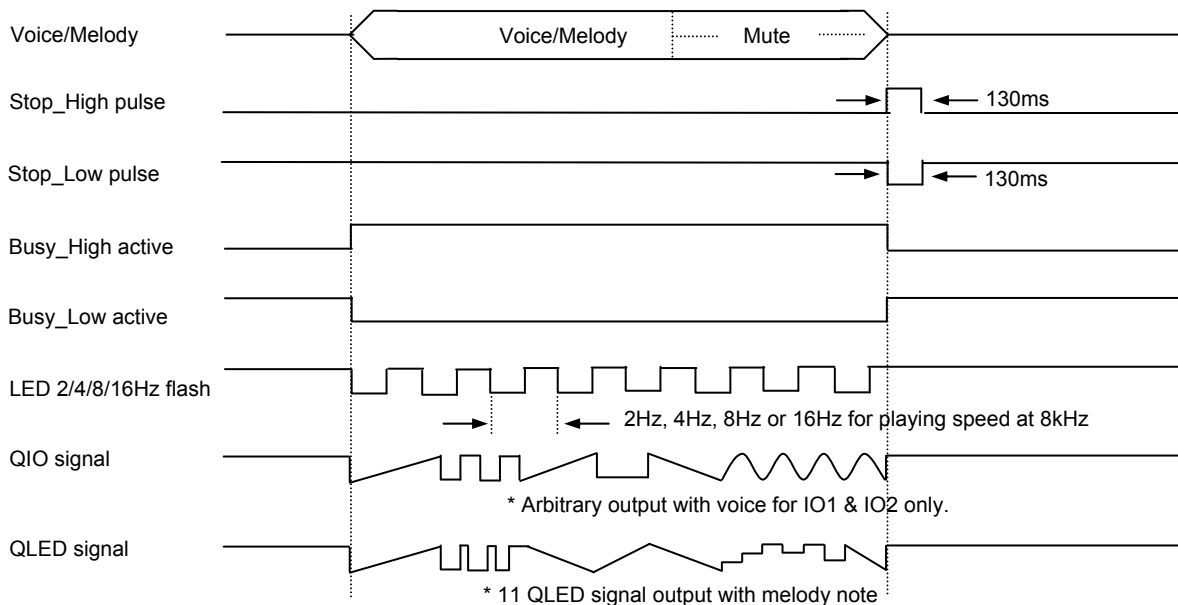

LED dynamic 1/2 or 3/4: When the voice amplitude is higher than 1/2 or 3/4 level, LED will be ON, e.g. output signal is low at sink mode.

(4) Basic Operation

(a). Edge mode, Short trigger

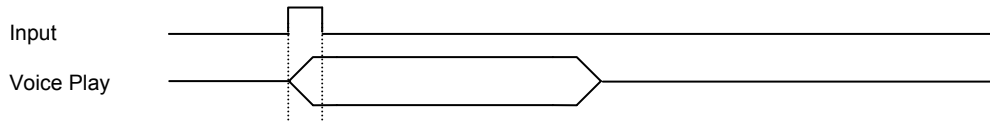

(b). Edge mode, Long trigger

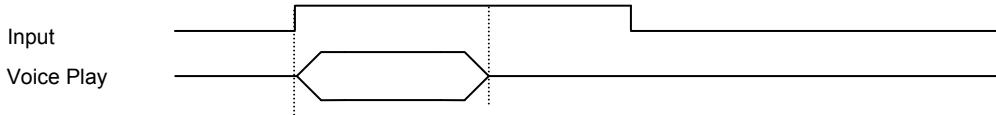

(c). Level mode, Short trigger

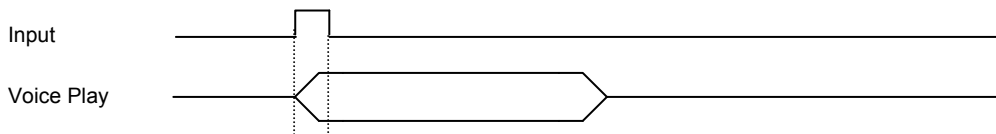

(d). Level mode, Long trigger

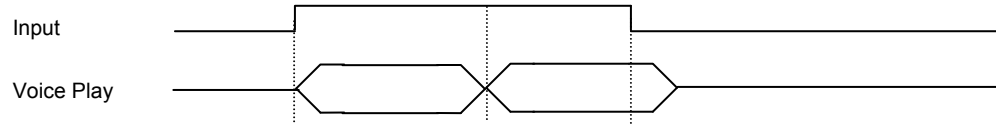

(e). Retrigger mode

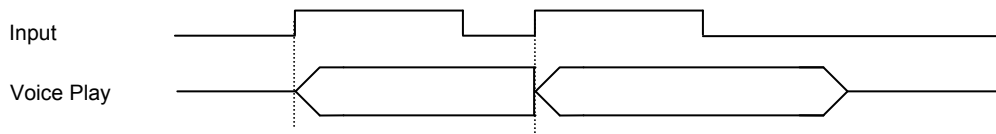

(f). Irretrigger mode

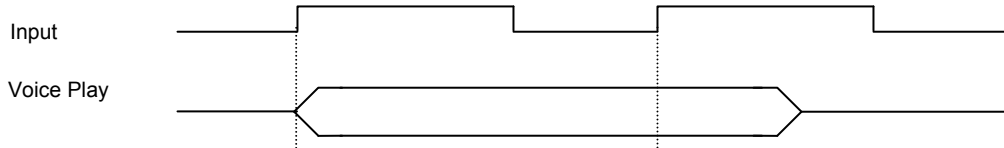

(g). Retrigger mode, first key priority

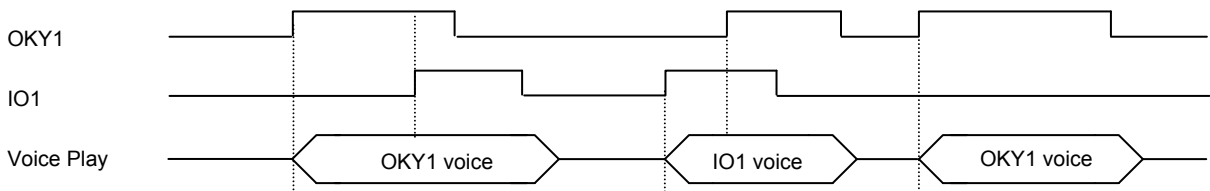

(5) Advanced Operation

(a). Different Input Reload (OKY1 is in Sequential mode)

(a-1) OKY1 (E/U/R) = S1 S2 S3 S4, IO1(E/U/R) = S5 (S1 means Sentence 1)

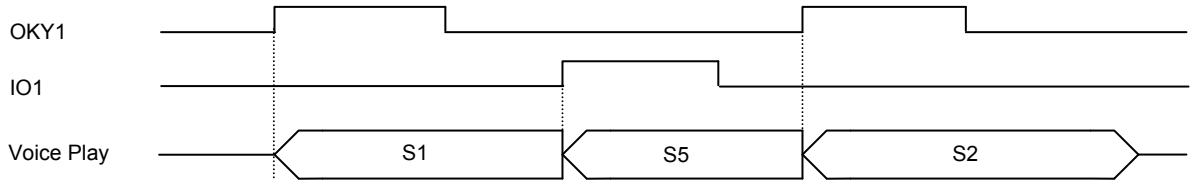

(a-2) OKY1 (E/U/R) = S1 S2 S3 S4, IO1 (L/x/x) = S5

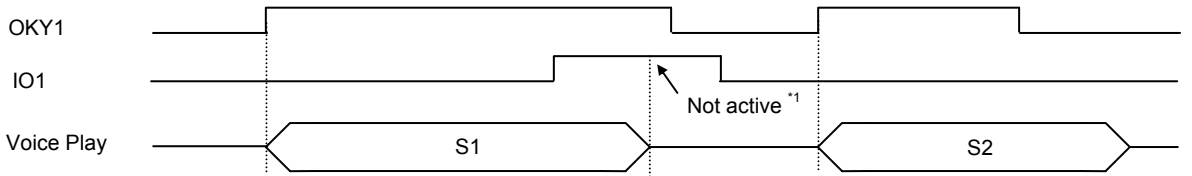

*1: If you press IO1 during OKY1 voice playing, at the moment of S1 end, the trigger mode follows OKY1

(a-3) OKY1 (E/U/I) = S1 S2 S3 S4, IO1 (E/x/x) = S5

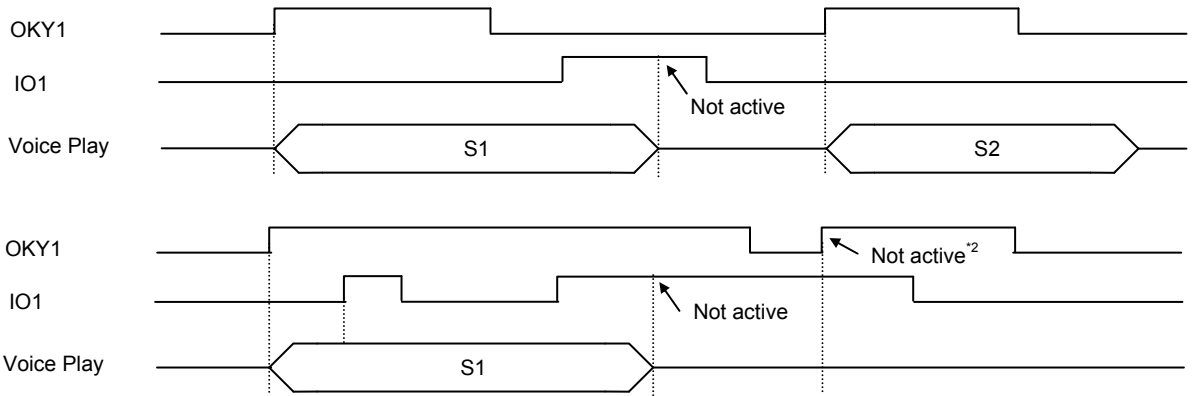

*2: Because IO1 signal is still high, in the same time IC can't accept the OKY1 Edge signal.

(a-4) OKY1 (E/U/I) = S1 S2 S3 S4, IO1 (L/x/x) = S5

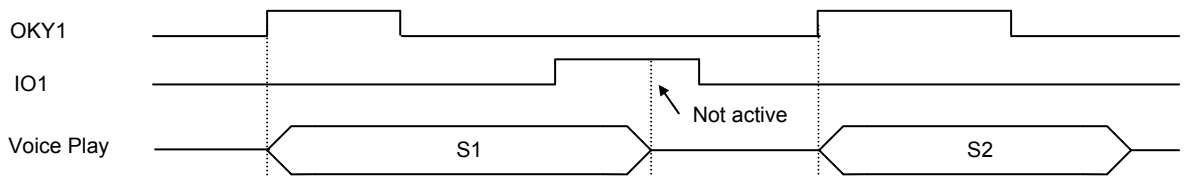

(a-5) OKY1 (L/U/x) = S1 S2 S3 S4, IO1 (E/x/x) = S5

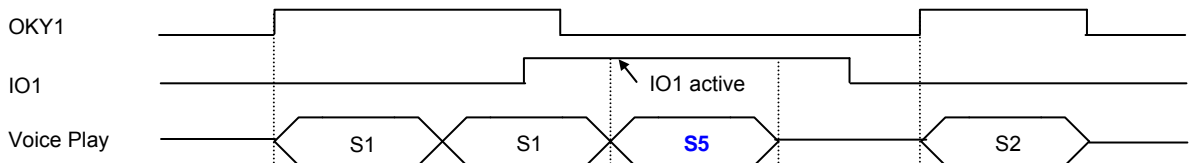

※ In the time of Sentence end: When S1 end, the trigger mode follows OKY1 (L/U/x). When S5 end, it follows IO1 (E/x/x).

※ Once S5 is played (just leave S1 ending), the trigger mode follows IO1 (E/x/x) immediately.

(a-6) OKY1 (L/U/x) = S1 S2 S3 S4, IO1 (L/U/I) = S5

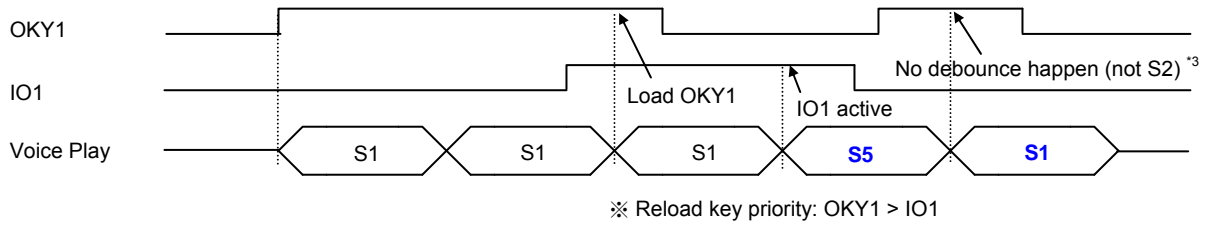

*3: In OKY1 mode, Sequential number is counted only if there is debounce happened.

(a-7) OKY1 (L/U/x) = S1 S2 S3 S4, IO1 (L/U/x) = S5

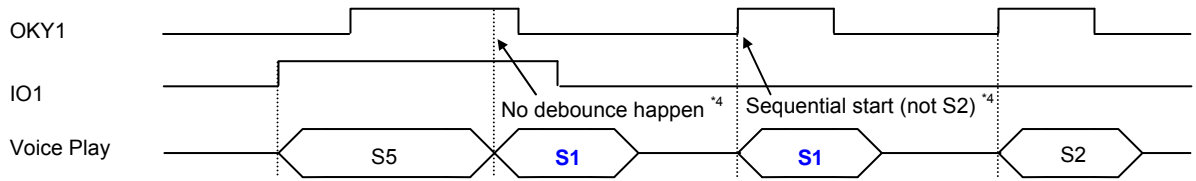

*4: In OKY1 mode, 1st trigger without debounce and Sequential number is still "1". 2nd trigger with debounce, after trigger the Sequential number become "2".

(b). Random Function

(b-1) OKY1 (L/U/I) = S1 S2 S3 S4, IO1 (L/U/I) = S5

Random (or Sequential) number is counted during "debounce time" or "key released time". But the first-time trigger only relies on "debounce time" due to no "key release time".

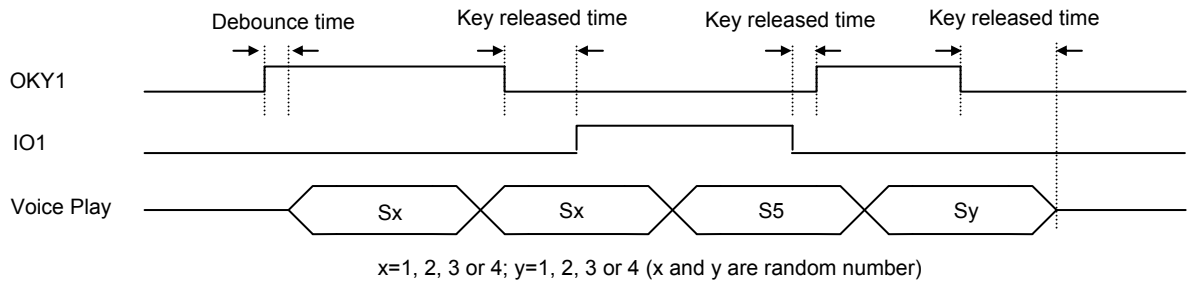

(b-2) OKY1 (L/U/R) = S1 S2 S3 S4, IO1 (L/U/R) = S5

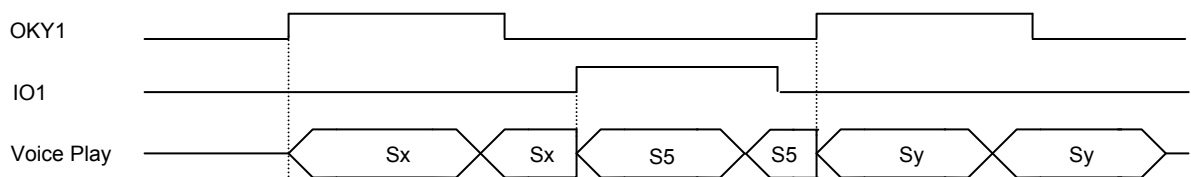

(c). Toggle On/Off Function

(c-1) OKY1 (E/U/R) = S1 S2 S3 S4, IO1 (E/U/R) = S5 (OKY1 is Sequential mode *without Reset*)

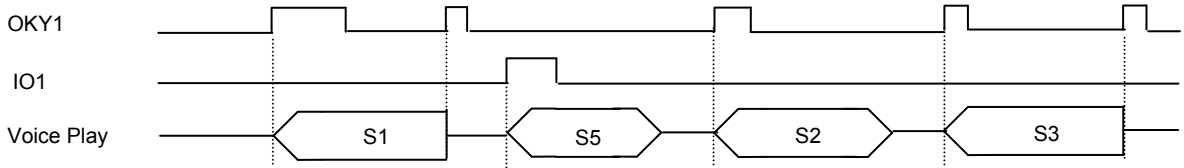

(c-2) OKY1 (E/U/R) = S1 S2 S3 S4, IO1 (E/U/R) = S5 (OKY1 is Sequential mode *with Reset*)

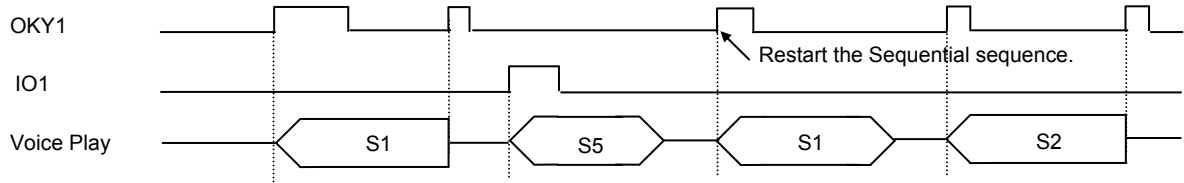

※ When OKY1 Sequential counter is going, to trigger other inputs will reset OKY1 Sequential sequence.

(d). External Feedback Function (IO1 is output and connected to OKY1 input)

(d-1) OKY1 (L/U/I) = S1 S2 S3 S4, IO1=Stop_high pulse (When voice ends, IO1 shows a high pulse.)

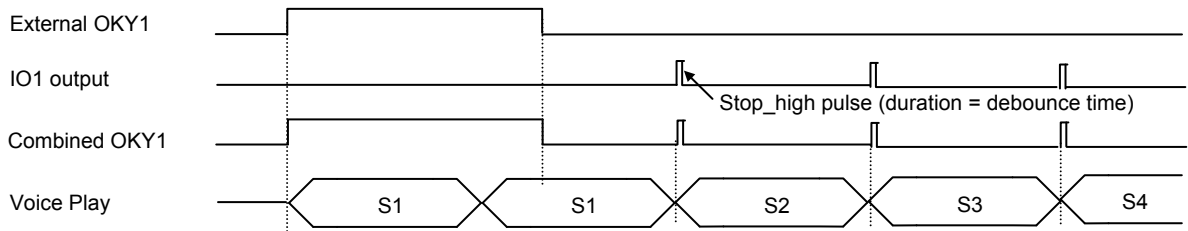

※ Originally the duration of Stop_high pulse is 130ms, but the high signal will trigger voice and turn low after debounce.

(d-2) OKY1 (E/U/I) = S1 S2 S3 S4, IO1= Busy_low (When not playing voice, IO1 is high.)

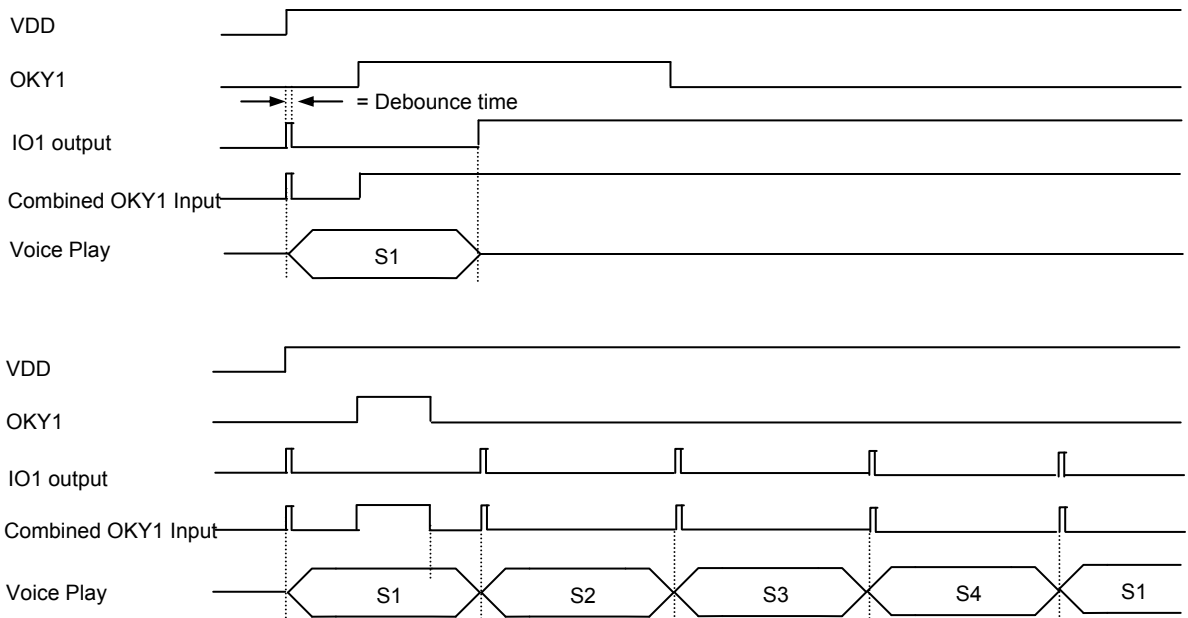

※ When power on, IO1 will generate a high pulse at Busy_low status and the duration is equal to debounce time.

(e). Internal-Feedback Function (IO2 is fixed as input)

Each sentence can assign an Internal-Feedback Path to play a fixed sentence after IO's sentence stop.

(e-1) OKY1 (L/U/I) = S1 S2 S3 S4, IO1= S5, Internal-Feedback Path = IO1

If S1 is optioned with Internal-Feedback Path,

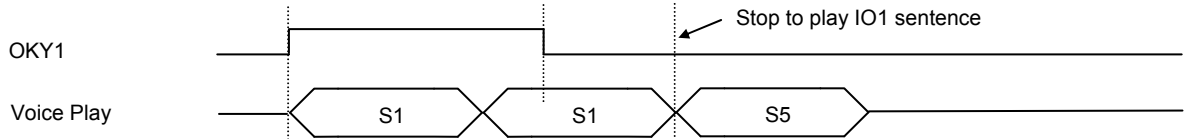

(e-2) OKY1 (L/H/I) = S1 S2 S3 S4, IO1 (x/x/R) = S5, IO2 (E/U/I) = S6, Internal-Feedback Path = IO1

If both S1 and S5 are optioned with Internal-Feedback Path,

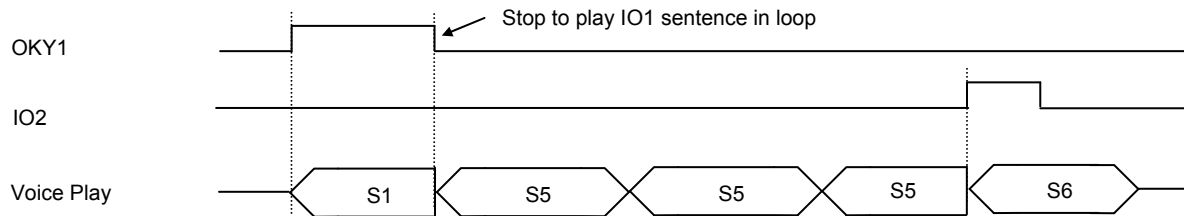

(f). Mode-Switch Function

If IO2 is set as Mode-Switch input, IO2→GND is for Mode-1 and IO2→VDD is for Mode-2.

(f-1) OKY1 (E/U/R) = S1 S2 S3 (Mode-1) & S33 S34 (Mode-2)

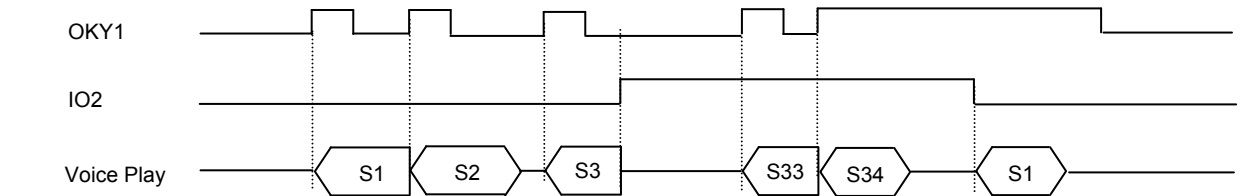

(f-2) OKY1 (E/U/R) = S1 S2 S3 (Mode-1) & S33 S34 (Mode-2), POP (E/U/R) =S5

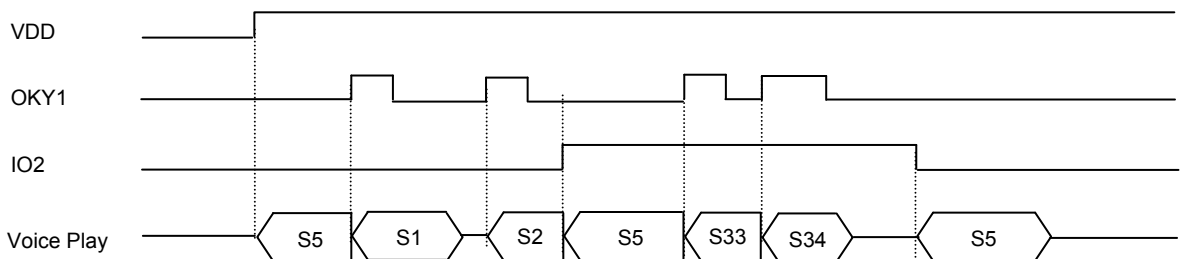

(g). Power-On-Play (POP) Function

The trigger mode of Power-On-Play is fixed as E/U/R, other trigger signal will stop POP's voice immediately and play the interrupted trigger's voice. POP can cooperate with Power-On-Loop function to play POP Sentence in loop.

(g-1) OKY1 (E/U/I) = S1 S2 S3 S4, POP (E/U/R) = S5

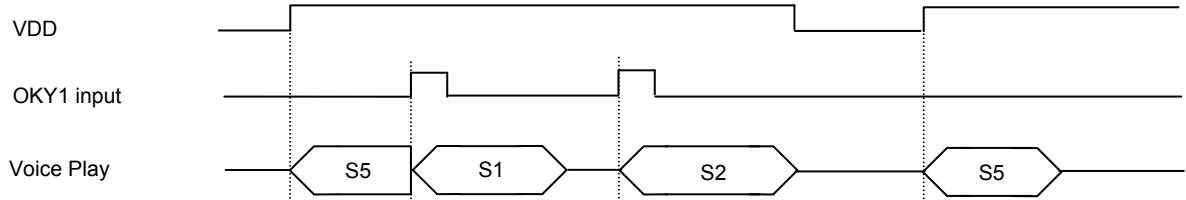

(g-2) OKY1 (E/U/I) = S1 S2 S3 S4, POP (E/U/R) = S5, Power-On-Loop is enabled.

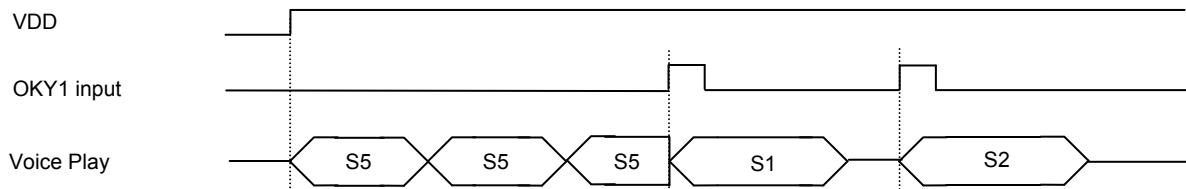

(h). Edge-Loop Function

(h-1) OKY1 (E/U/R) = S1 S2 S3

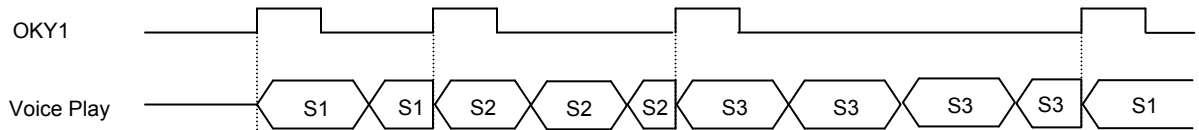

(h-2) OKY1 (E/U/R) = S1

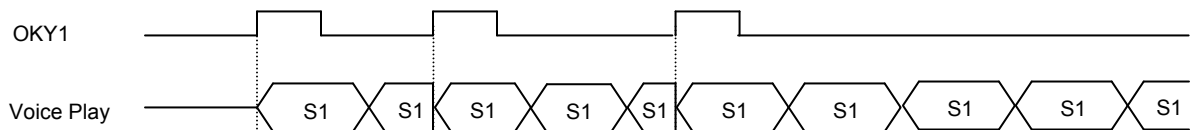

(h-3) OKY1 (E/U/R) = S1 S2 S3, Loop On/Off is enabled.

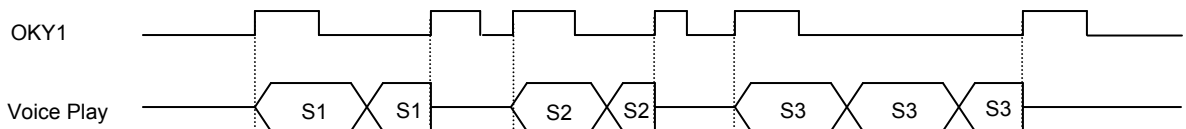

(h-4) OKY1 (E/U/R) = S1 S2 S3, Loop-End is enabled.

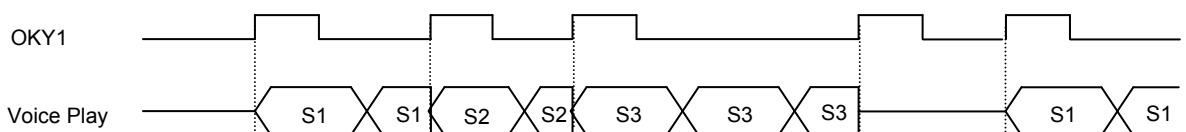

(i). Level-Sequential Function

(i-1) OKY1 (L/U/R) = S1 S2 S3

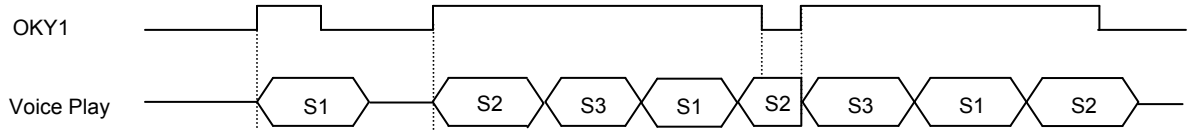

(i-2) OKY1 (L/H/x) = S1 S2 S3

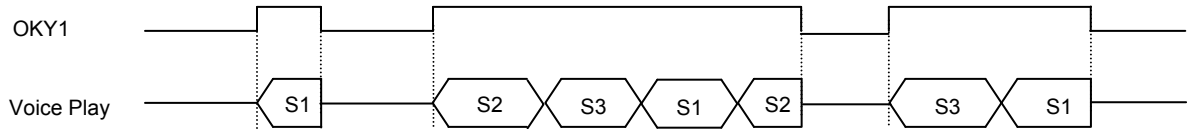

(j). Level-Sequential + Edge-Loop Function

(j-1) OKY1 (L/U/R) = S1 S2 S3

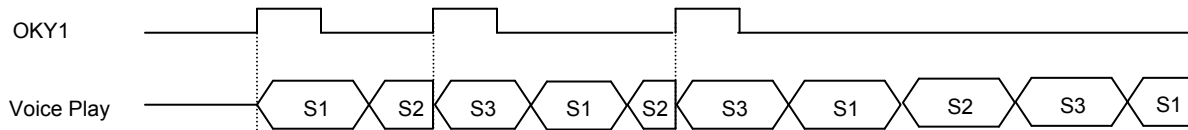

(j-2) OKY1 (L/U/R) = S1 S2 S3, Loop On/Off is enabled.

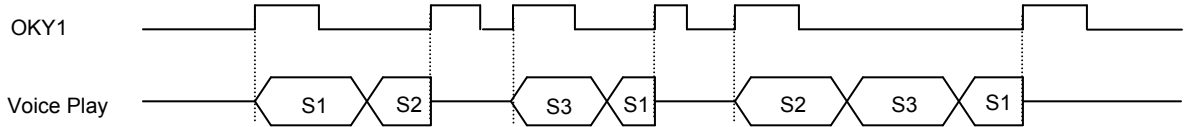

(k). Voice-Select Function

(k-1) OKY1 (E/U/R) = S1 S2 S3, IO2 (E/U/I) = OKY1's sentence

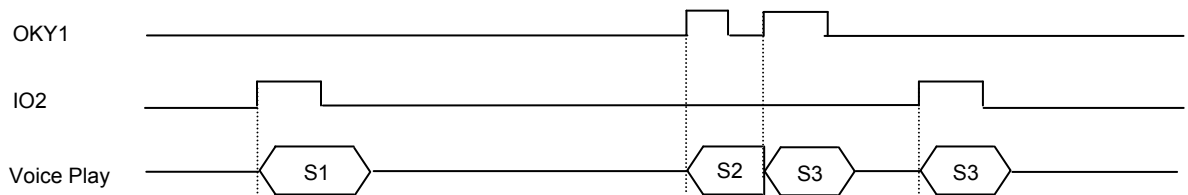
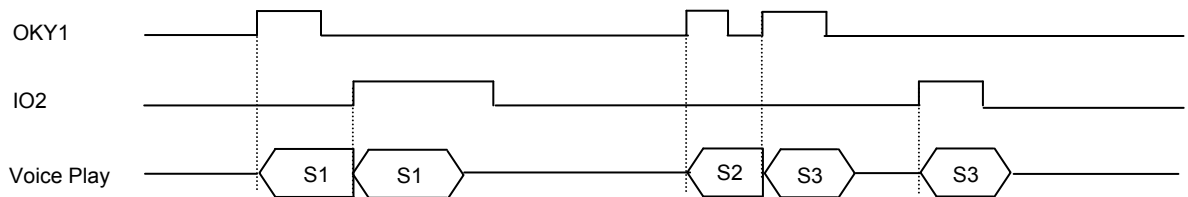

(k-2) OKY2 (E/U/R) = S1 S2 S3, IO1 (L/U/R) = OKY2's sentence

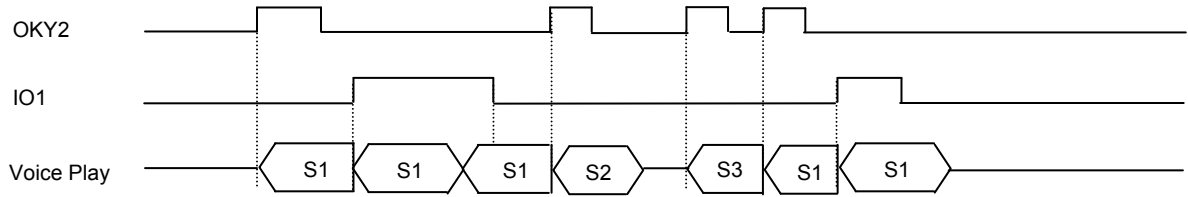

(l). Alarm/Snooze Function

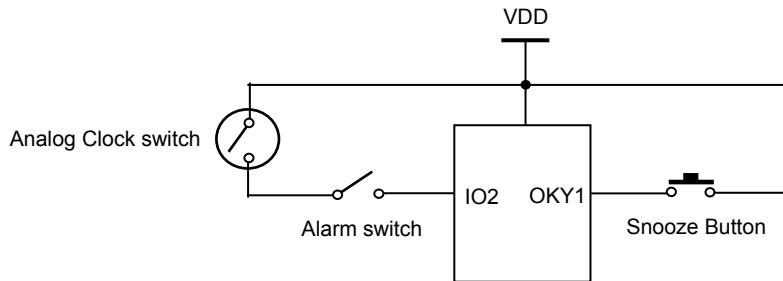

(l-1) OKY1 (E/U/R) = S1 S2 S3 S4, IO2 (L/x/R) = S5, Loop Sentence = S6, Jump Sentence = S7

If S1 is 5 minutes mute, S2 is 4 minutes mute, S3 is 3 minutes mute, S4 is 3 minutes mute,

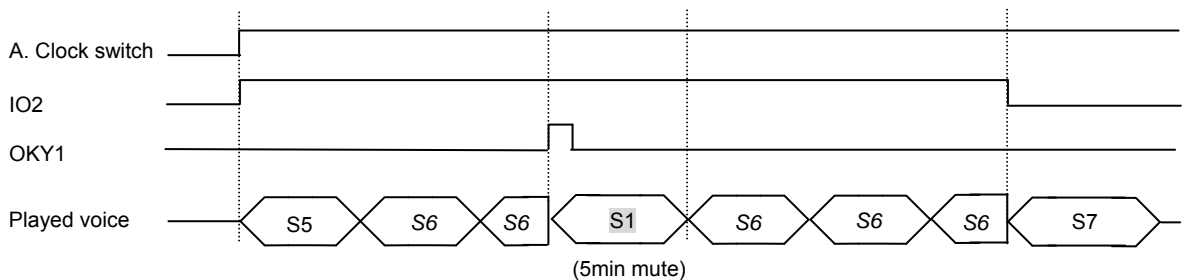
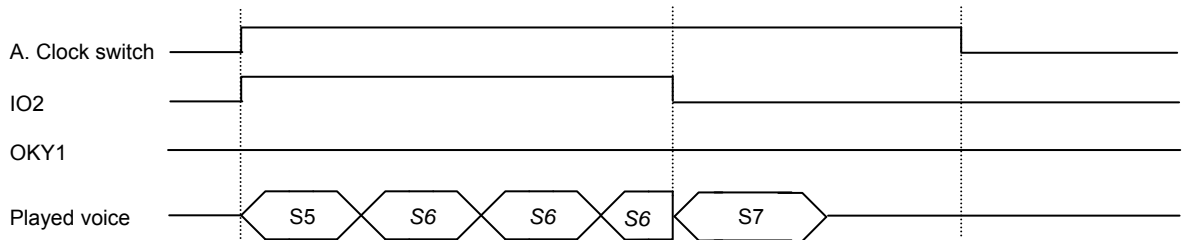
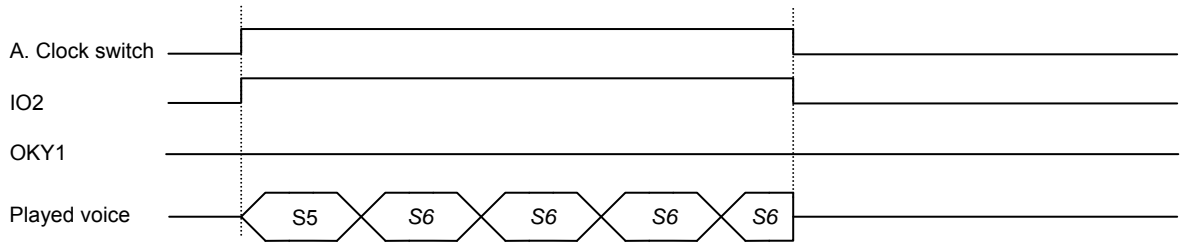

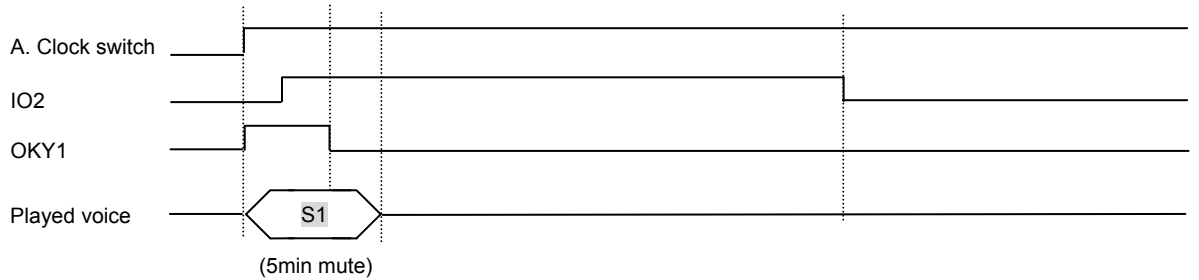
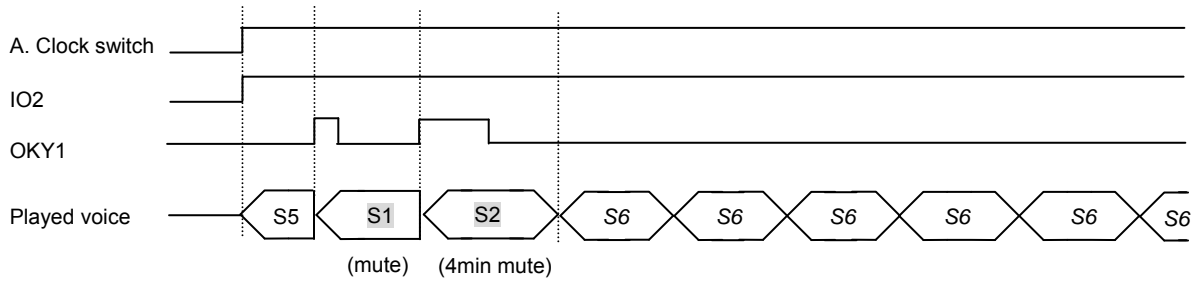
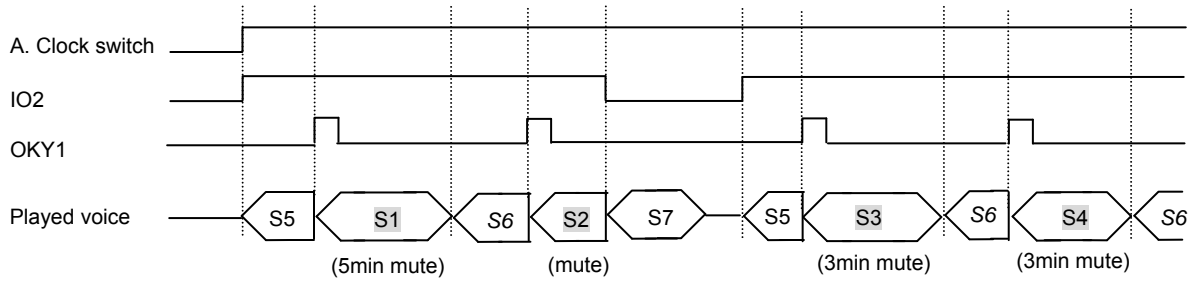
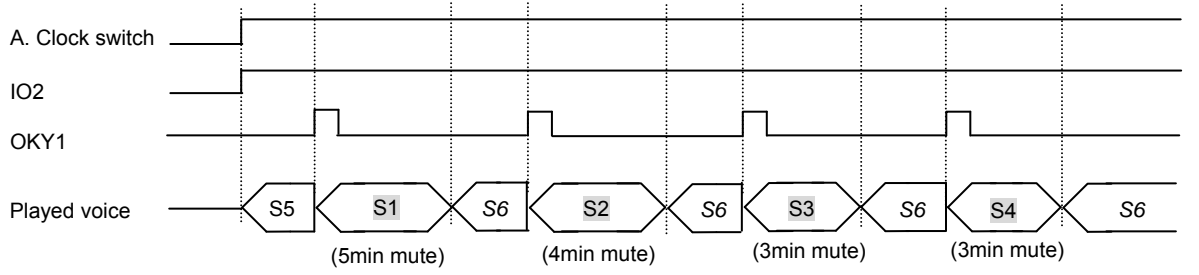

※ If OKY1 is triggered first and hold, IC can't detect IO2 trigger signal because the trigger mode follows OKY (E/U/R).

9. APPLICATION

(1) 2 Alone triggers with 4 LEDs (Sink)

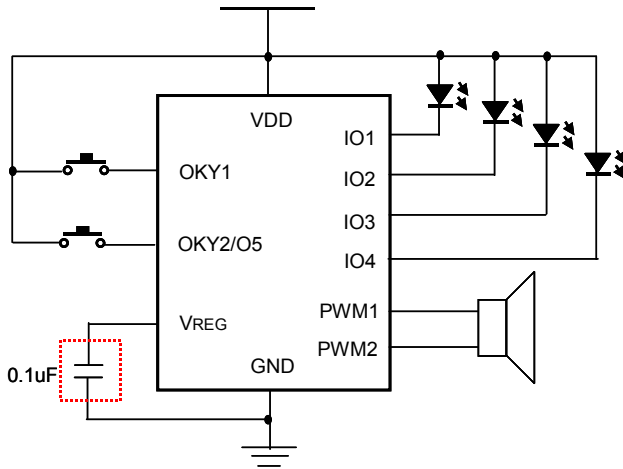

(2) 6 Matrix triggers with 2 LEDs (Drive)

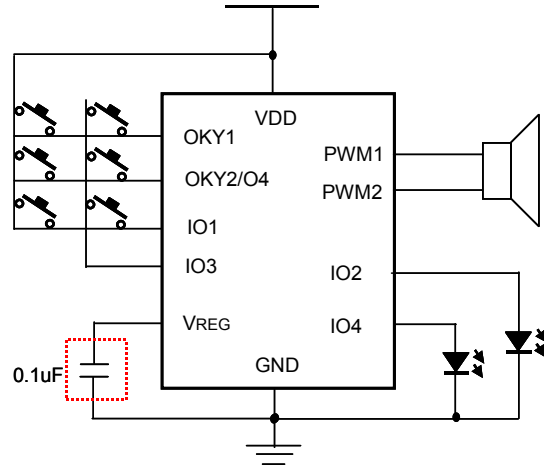

(3) 3 Alone triggers with 2 LEDs (Sink) and 1 motor (Drive)

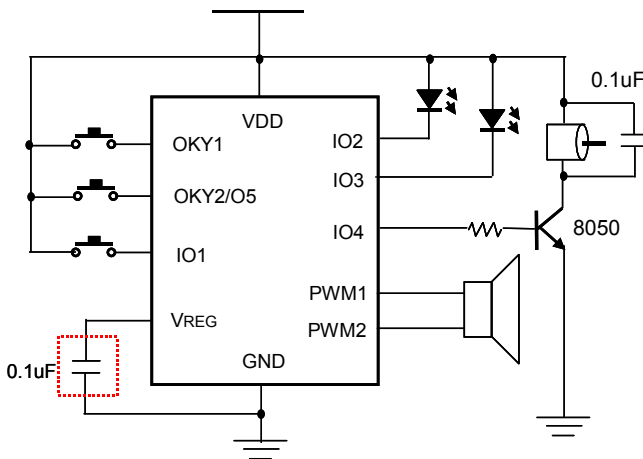

(4) 3 Alone triggers with 2 LEDs (Sink) and 1 motor (Sink)

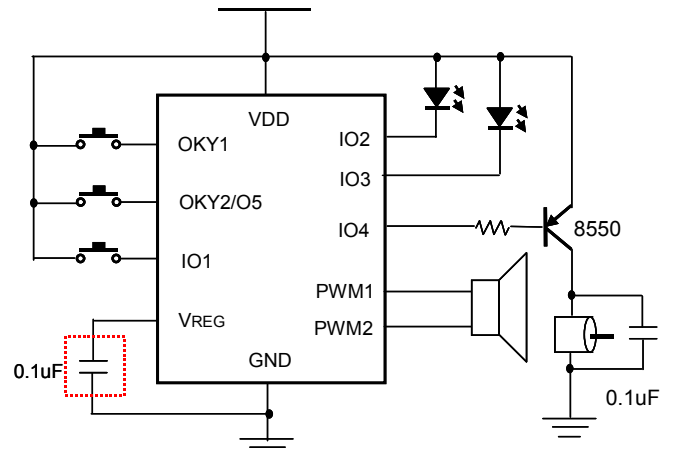

Note: At high voltage of 4.5V or higher voltage, V_{REG} may be connected to GND with a 0.1uF cap for less power noise. At 3V, V_{REG} doesn't need to connect any capacitor and can be kept this pad floating to save a capacitor.

10. DIE PAD DIAGRAM

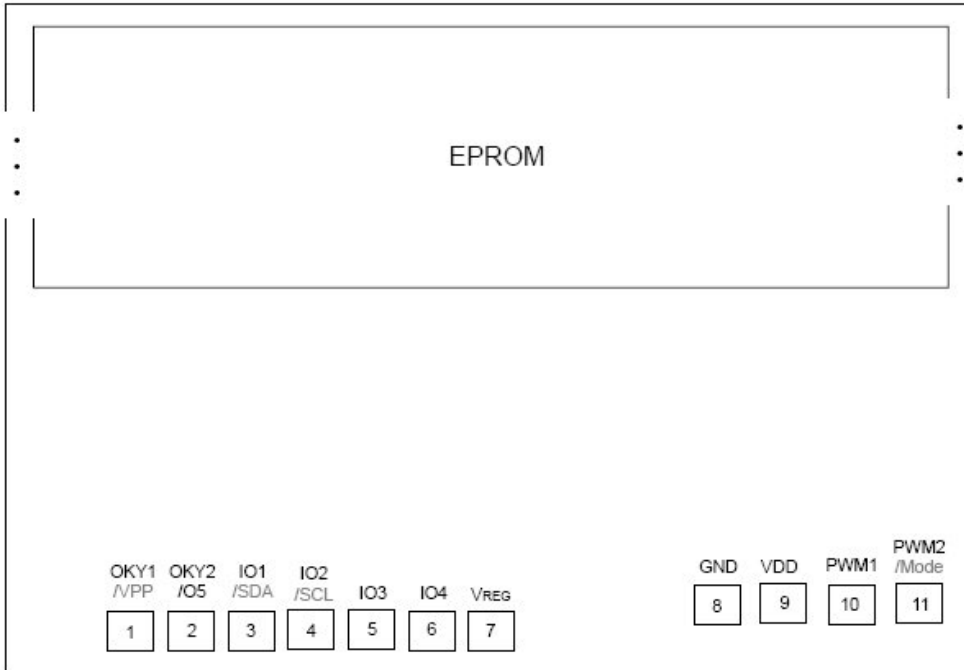

* The IC substrate must be connected to GND or Floating.

11. COB PIN ASSIGNMENT

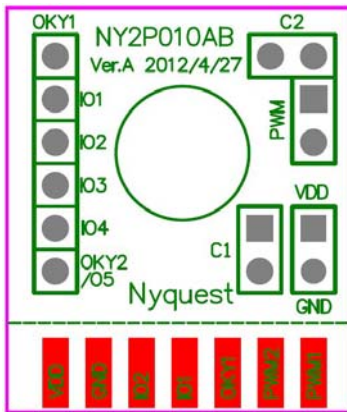

*Note: C1 is VDD power cap.
C2 is VREG cap.*

12. PACKAGE PIN ASSIGNMENT

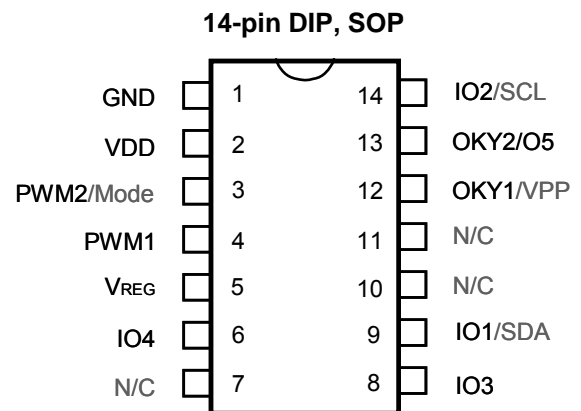
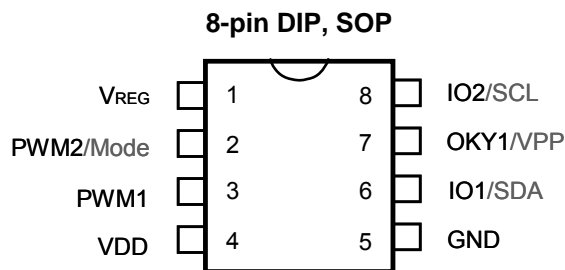

13. PACKAGE DIMENSION

8-Pin Plastic DIP (300 mil)

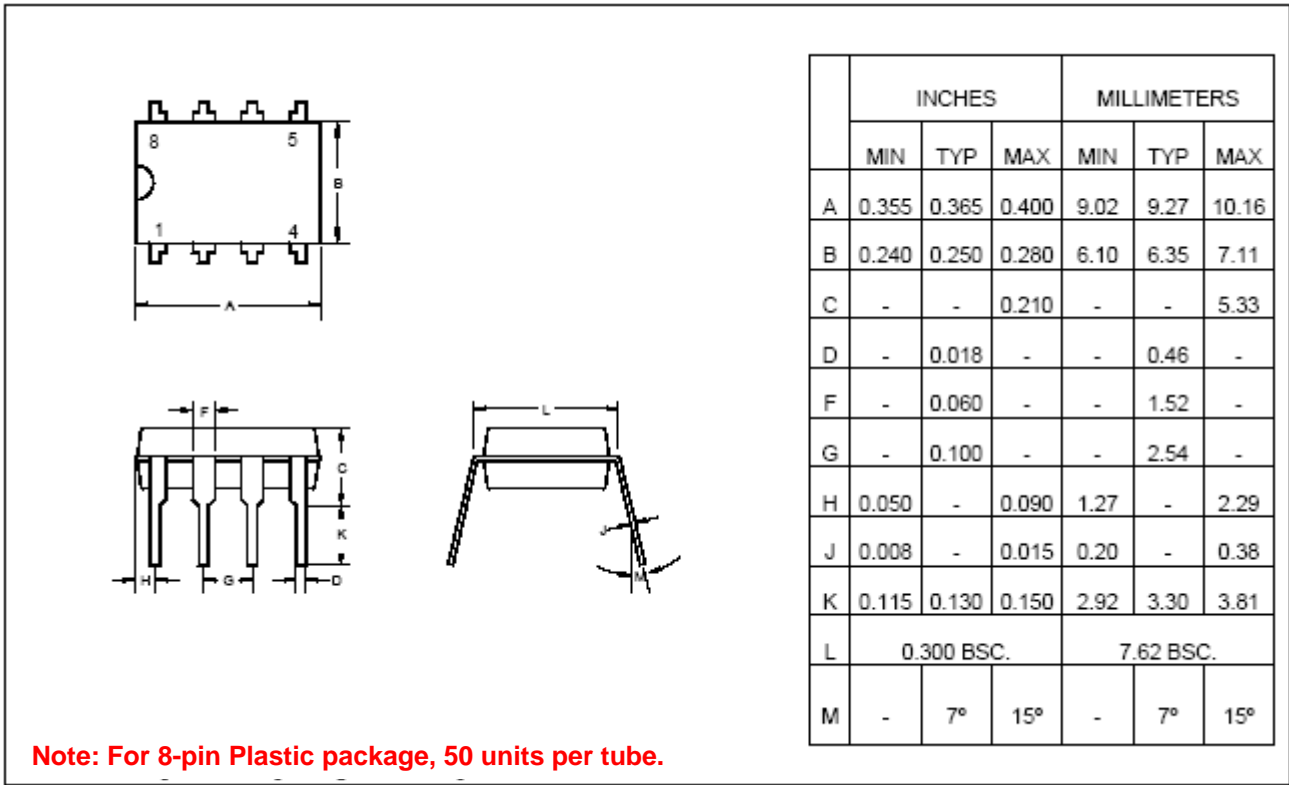

8-Pin Plastic SOP (150 mil)

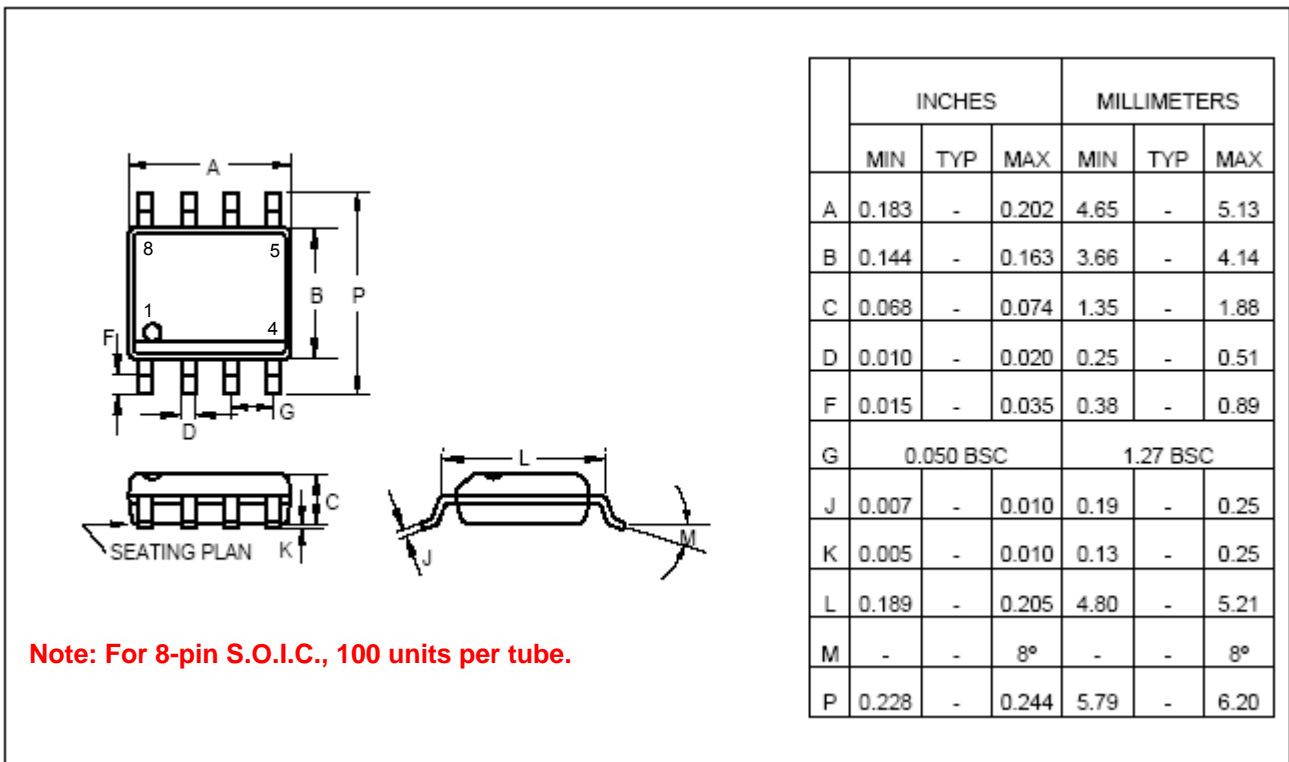

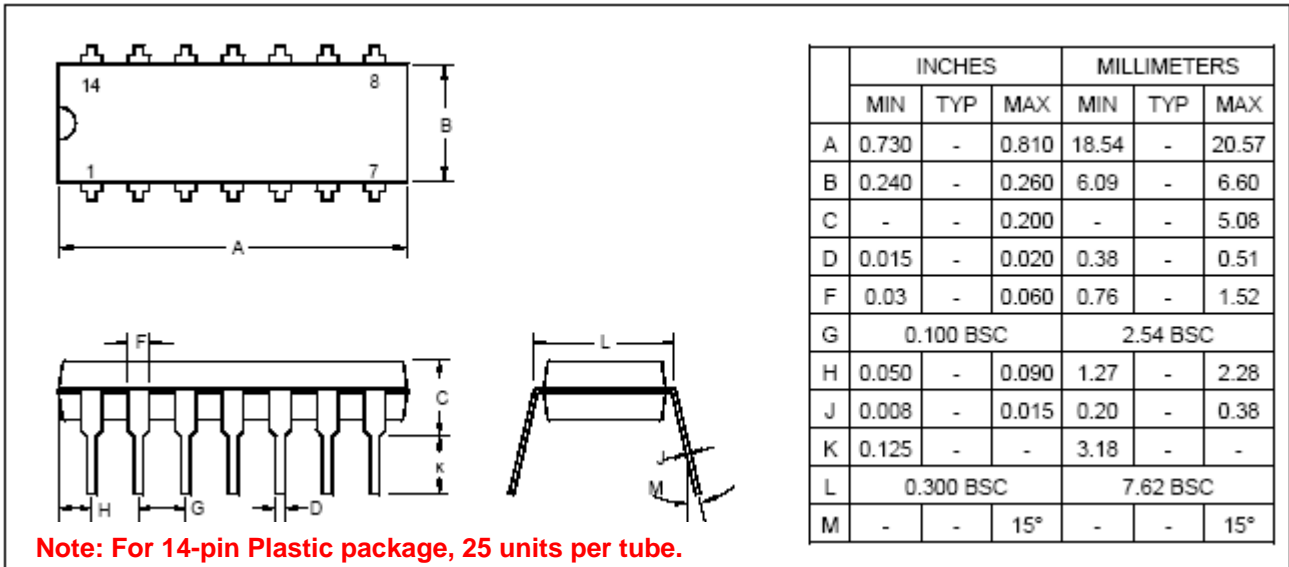
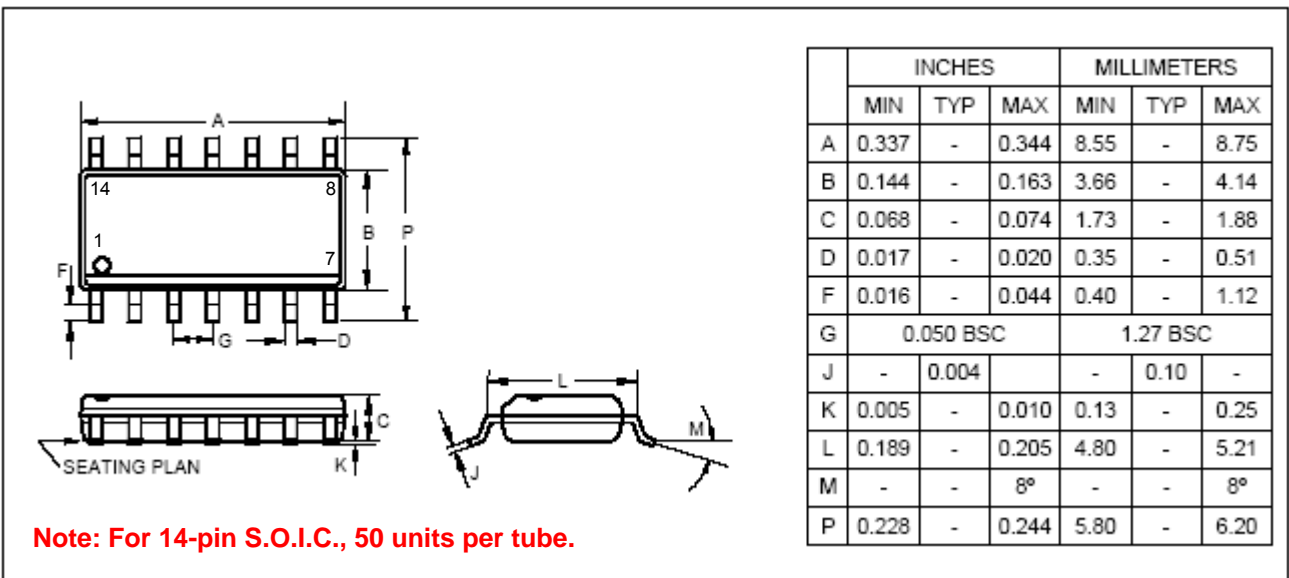
14-Pin Plastic DIP (300 mil)

14-Pin Plastic SOP (150 mil)

14. ORDERING INFORMATION

<i>P/N</i>	<i>Shipping Type</i>	<i>Remarks</i>
NY2P010A	Die	Empty ROM data
NY2P010A-xxxx ^{*1}	Die	Programmed ROM data
NY2P010AW-xxxx ^{*1}	Wafer	Programmed ROM data
NY2P010AB	COB	20.3 mm x 18.6 mm (20mm x 23.9 mm w/ V-Cut)
NY2P010AP8	DIP-8	Width 300 mil
NY2P010AS8	SOP-8	Width 150 mil
NY2P010AP14	DIP-14	Width 300 mil
NY2P010AS14	SOP-14	Width 150 mil

*1 "xxxx": Code number.